

公差表 (General Tolerances)(mm)													
0	>3	>6	>10	>18	>30	>50	>80	>120	>180	>250	>315	>400	0.1/1.0
~	~	~	~	~	~	~	~	~	~	~	~	~	±Z
3	6	10	18	30	50	80	120	180	250	315	400	500	
±0.12	±0.18	±0.22	±0.26	±0.31	±0.37	±0.57	±0.80	±0.93	±1.05	±1.15	±1.60	±2.20	±2.50

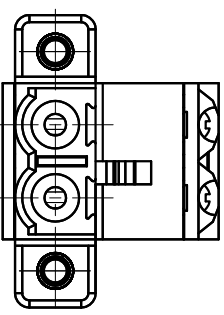
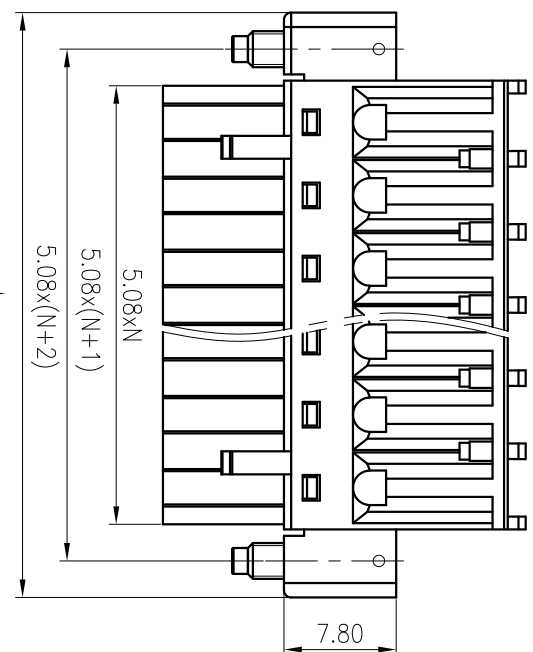
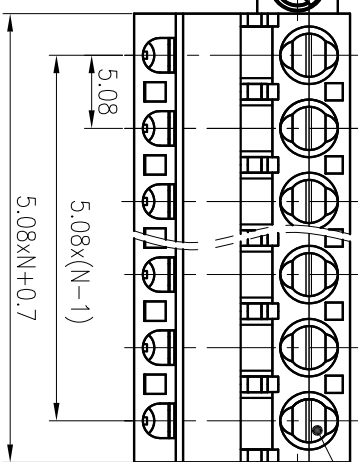
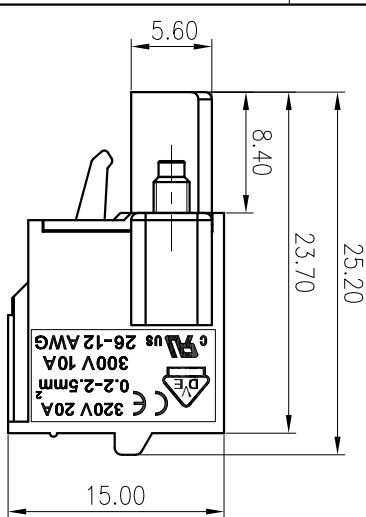
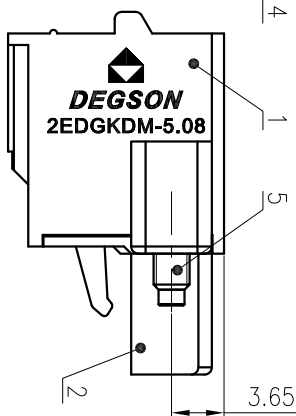
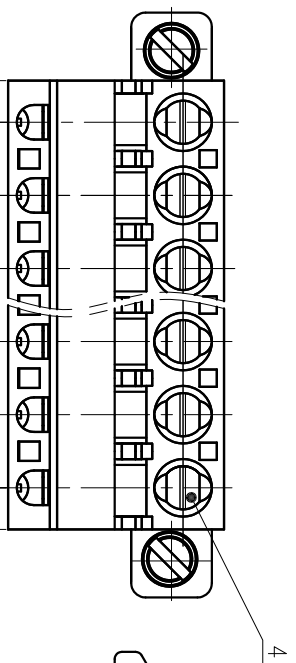
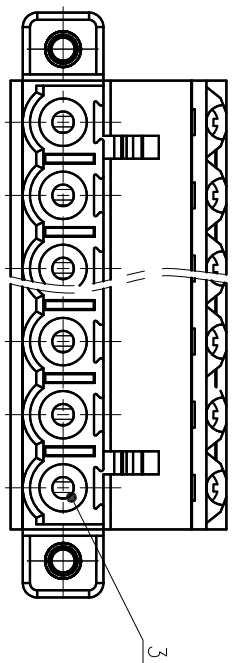

ITEM	NAME OF PART	MATERIAL	NOTES
1	Housing	PA66	UL94V-0
2	Cover	PA66	UL94V-0
3	Clamp	Copper alloy	Sn Plated
4	Spring	Stainless steel	/
5	Screw	Steel	M2.5/7m Plated

UL 标准/UL Standard:	B	C	D
额定电压/电压/Rated Voltage(V)/Current(A)	300/10	/	300/10
EC 标准/IEC Standard:			
过压类别/Overvoltage Category/污染等级/ Pollution Degree	III/3	III/2	II/2
额定电流/电流/Rated Voltage(V)/Current(A)	/	320/20	/
额定冲击电压(KV)/Rate Impulse Voltage(KV)	/	4	/
螺栓扭矩/Torque Tightening(N·m/Lb·in)	M2.5, 0.4/3.54		
导线范围(硬线和软线)/Wire Range(rigid and flexible)(mm <sup>2</sup> /AWG)	0.2~2.5/26~12		
间距/Pitch(mm)/线数范围/Poles	5.08/N=02~16P		
剥线长度/Stripping length(mm)	9~10		
使用温度范围/Operating temperature(°C)	-40~+105		
符合RoHS环保要求/Conform to RoHS	Yes		

MATERIAL: / SURFACE: /

MAT NO.: /  
 STATUS: /  
 APPD: LI GL 2020.05.18  
 CHKD: Ma EK 2020.05.18  
 DRAFT: YanH 2019.09.24

NAME: **DEGSON** 宁波高松电子有限公司  
 NINGBO DEGSON ELECTRICAL CO., LTD

DRAWING NO.: 2EDGKDM-5.08-C01  
 TYPE: CUSTOMER DRAWING  
 SCALE: 2:1  
 SHEET 1/1

REV	ECN	DESCRIPTION	DRAFT	DATE
1				
2				
3				
4				